

# WTO

## *nanoFlex*<sup>®</sup>

新一代快换系统  
设计紧凑，高精度

低投资，高扩展性

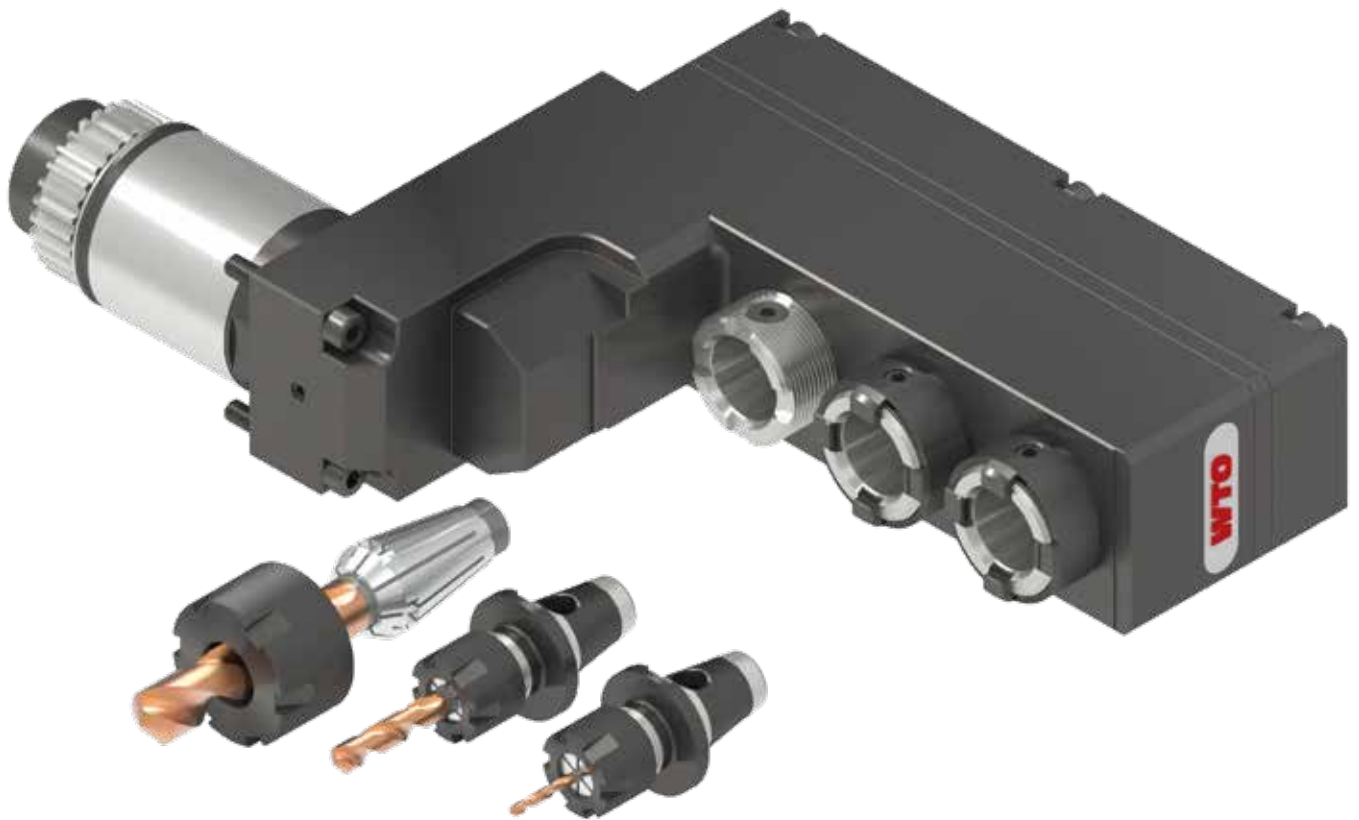

走心机  
专用

# nanoFlex®

ER筒夹和模块化快换系统，在同一把刀座上完美兼容

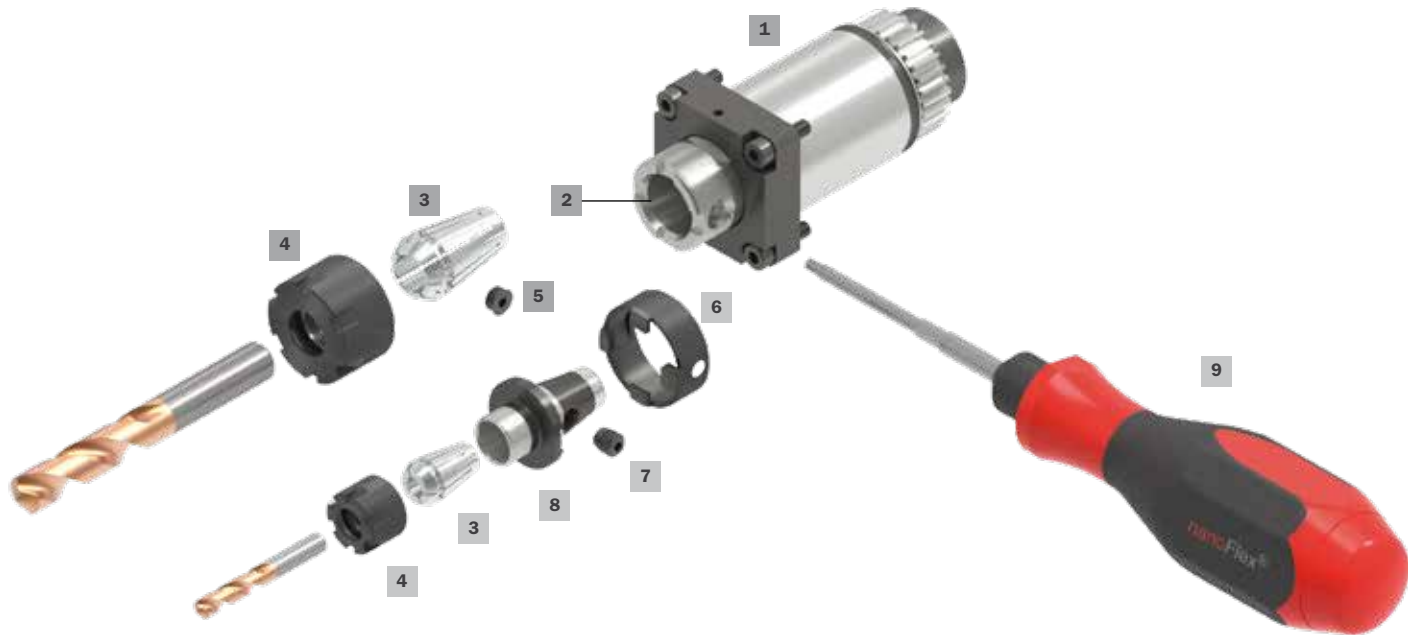

完成安装适配器准备的  
nanoFlex® 夹头

- 1 - 刀座
- 2 - nanoFlex® 夹头
- 3 - ER 筒夹
- 4 - 锁紧螺帽
- 5 - 堵头螺丝，用于主轴侧面
- 6 - nanoFlex® 快换适配器扭矩传输驱动环
- 7 - nanoFlex® 锁紧螺丝
- 8 - nanoFlex® 快换适配器
- 9 - 预设扭矩单手扳手，用于锁紧及  
松开nanoFlex® 快换适配器
- 10 - 扭矩传输驱动键
- 11 - ER筒夹和nanoFlex® 快换适配器接触锥面



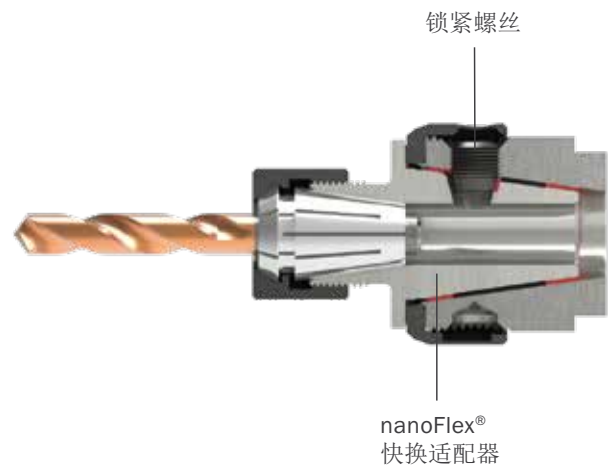
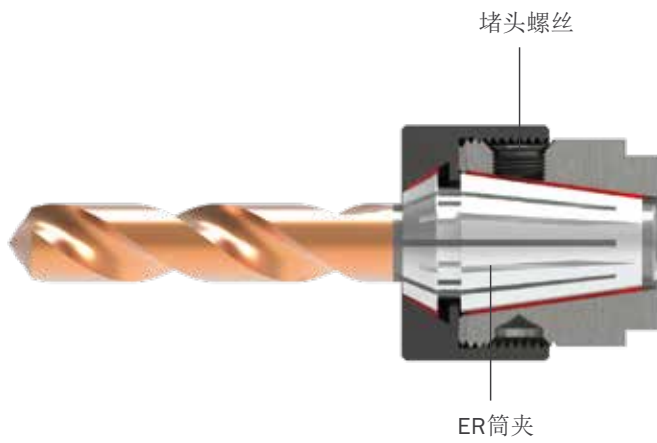

常规筒夹夹持刀具

使用快换适配器夹持刀具



## 快换适配器操作

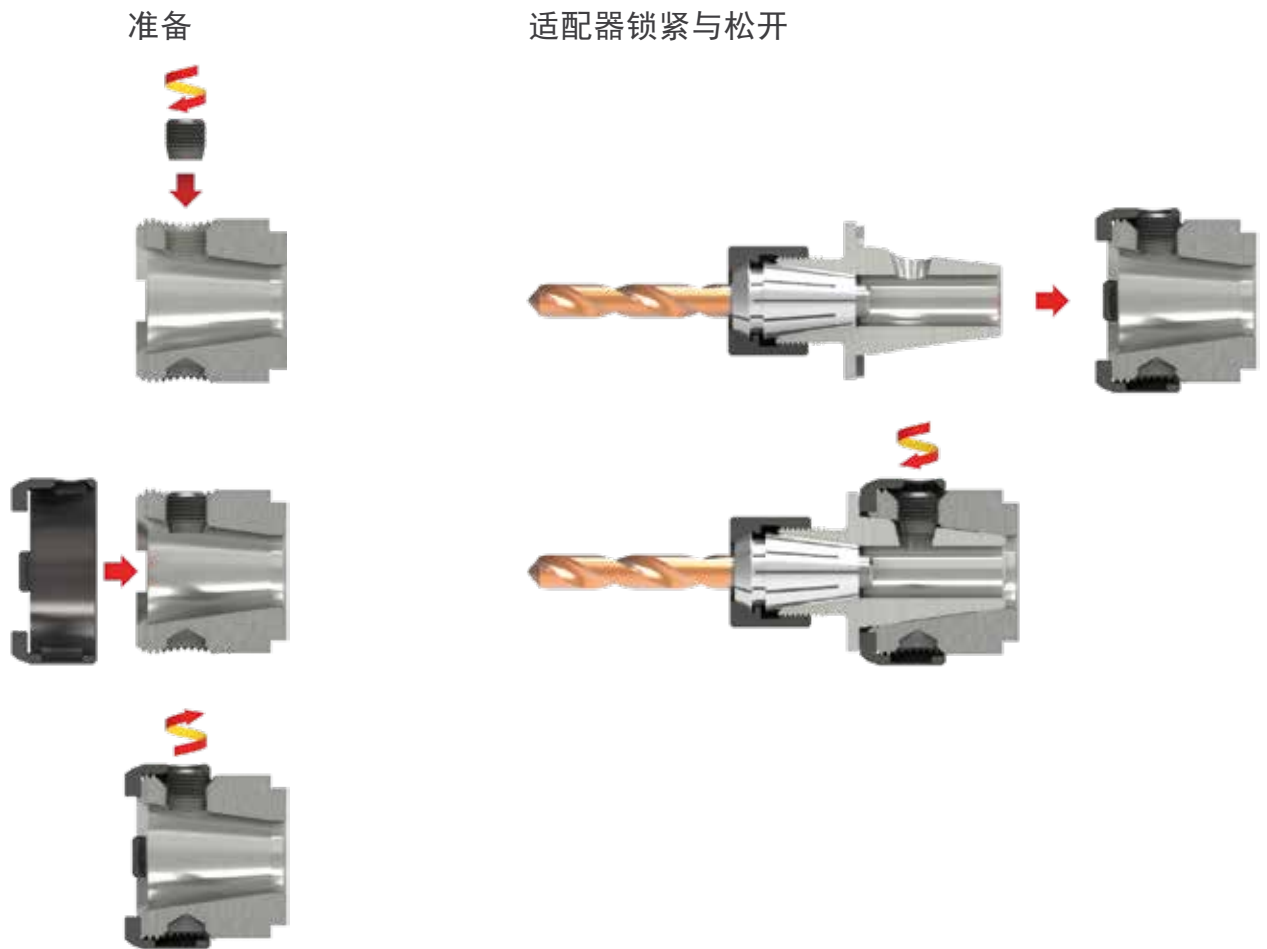

## 筒夹操作

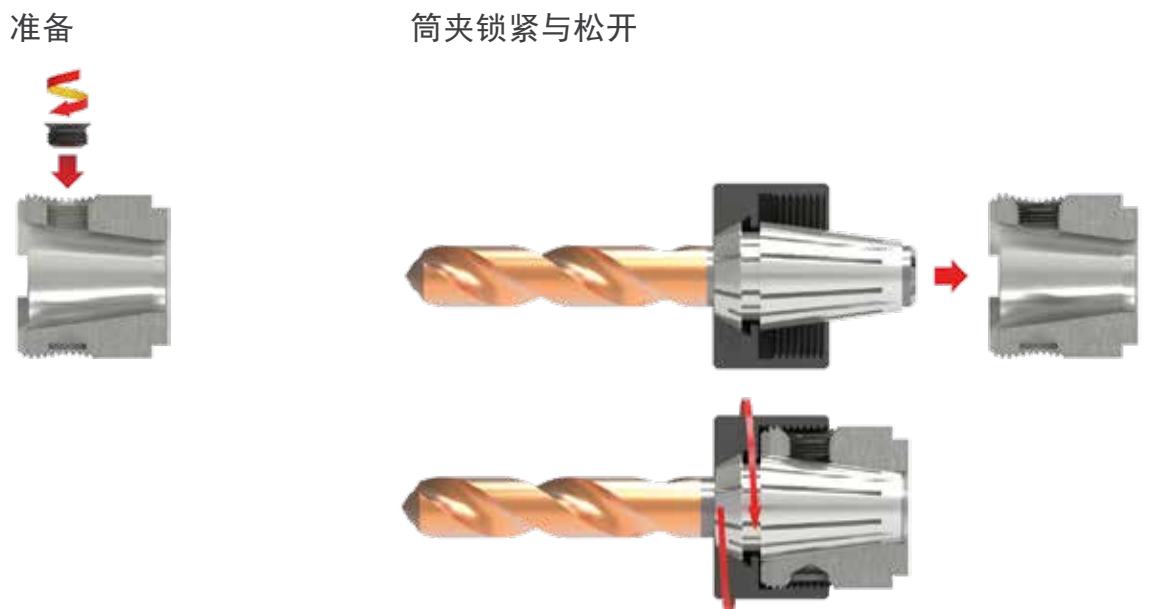

## 圆柱形刀柄

有圆柱柄及平面

灵活应用ER筒夹和nanoFlex® 适配器到镗刀座和套筒刀座

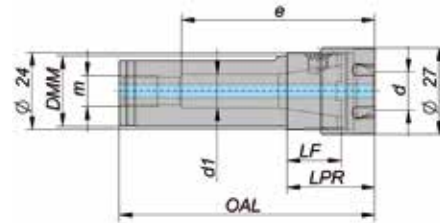



规格	型号	DMM	d min.	d max.	LF	LPR	OAL	d <sub>1</sub>	m	e			
ER-16NF	NF16-SSH-075-A	¾"	0,5	10	17	28,5	78,5	10,5	G <sup>1</sup> / <sub>8</sub> "	60,5	NF16-SCN-A	107520005	NF16-SPLA
ER-16NF	NF16-SSH-022-A	22	0,5	10	17	28,5	80	10,5	G <sup>1</sup> / <sub>8</sub> "	60,5	NF16-SCN-A	107520005	NF16-SPLA
ER-16NF	NF16-SSH-025-A	25	0,5	10	17	28,5	78,5	10,5	G <sup>1</sup> / <sub>8</sub> "	60,5	NF16-SCN-A	107520005	NF16-SPLA

尺寸单位为mm. 包含锁紧螺帽和堵头螺丝ER-16NF

## 筒夹适配器

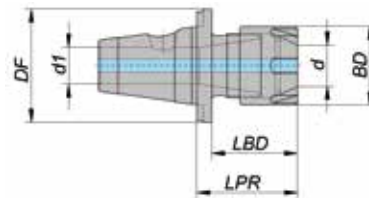
DIN 6499, ISO 15488





规格	型号	DF	d min.	d max.	d <sub>1</sub>	BD	LPR	LBD	筒夹规格		
ER-16NF	NF16-SAD-ER08-A	23	0,5	5	5,5	12	20,5	17,5	ER 8	200508000	107508005
ER-16NF	NF16-SAD-ER11-A	23	0,5	7	7,5	16	20,5	17,5	ER 11	200511000	107511005

尺寸单位为mm

## Weldon/Whistle Notch侧固适配器

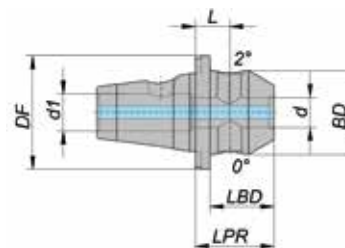
适用于DIN6535-HB和-HE刀柄



规格	型号	DF	d	BD	LPR	LBD	L	d <sub>1</sub>		
ER-16NF	NF16-SAD-WW06-A	23	6	17	16	13	7	7,5	12882	26071

尺寸单位为mm

## 测试棒/预调标准长度规 刻有实际测量长度

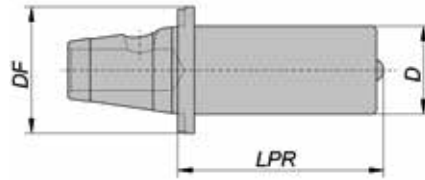



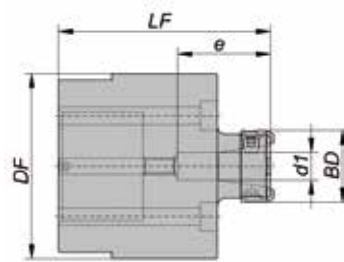

规格	型号	DF	D	LPR
ER-16NF	NF16-SMA-A	23	16	37,5

尺寸单位为mm

## nanoFlex® 装配及机外对刀装置 适用于nanoFlex® 适配器刀具更换和机外对刀



规格	型号	DF	BD	LF	d <sub>1</sub>	e				
ER-16NF	NF16-SMD-A	70	27	80	10,5	35	NF16-STW-A	NF16-SDR-A	NF16-SCS-A	29205



尺寸单位为mm

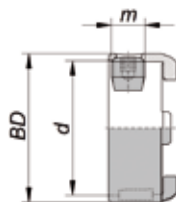

## 驱动环

适用于nanoFlex® 适配器



规格	型号	BD	d	m			
ER-16NF	NF16-SDR-A	27	24	M6x0,5	10IP	NF16-SCS-A	NF16-STW-A

尺寸单位为mm, 包含锁紧螺丝

## 扭矩螺丝刀

适用于单手锁紧nanoFlex® 适配器



注：  
螺丝刀柄部可更换

规格	型号		Nm	
ER-16NF	NF16-STW-A	10IP	2,5	109330

尺寸单位为mm

## 锁紧螺丝 ERNF

适用于锁紧nanoFlex® 适配器



规格	型号		Nm	
ER-16NF	NF16-SCS-A	10IP	2,5	NF16-STW-A

尺寸单位为mm

## 锁紧螺帽 ERNF

适用于nanoFlex® 主轴筒夹锁紧

DIN 6499, ISO 15488

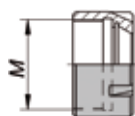



规格	型号	M	Nm	
ER-16NF	NF16-SCN-A	M24x1	45	107520005

尺寸单位为mm

## 堵头螺丝 ERNF

适用于封闭锁紧螺丝孔位



规格	型号		Nm	
ER-16NF	NF16-SPL-A	10IP	2,5	NF16-STW-A

尺寸单位为mm

# WTO 全球分布

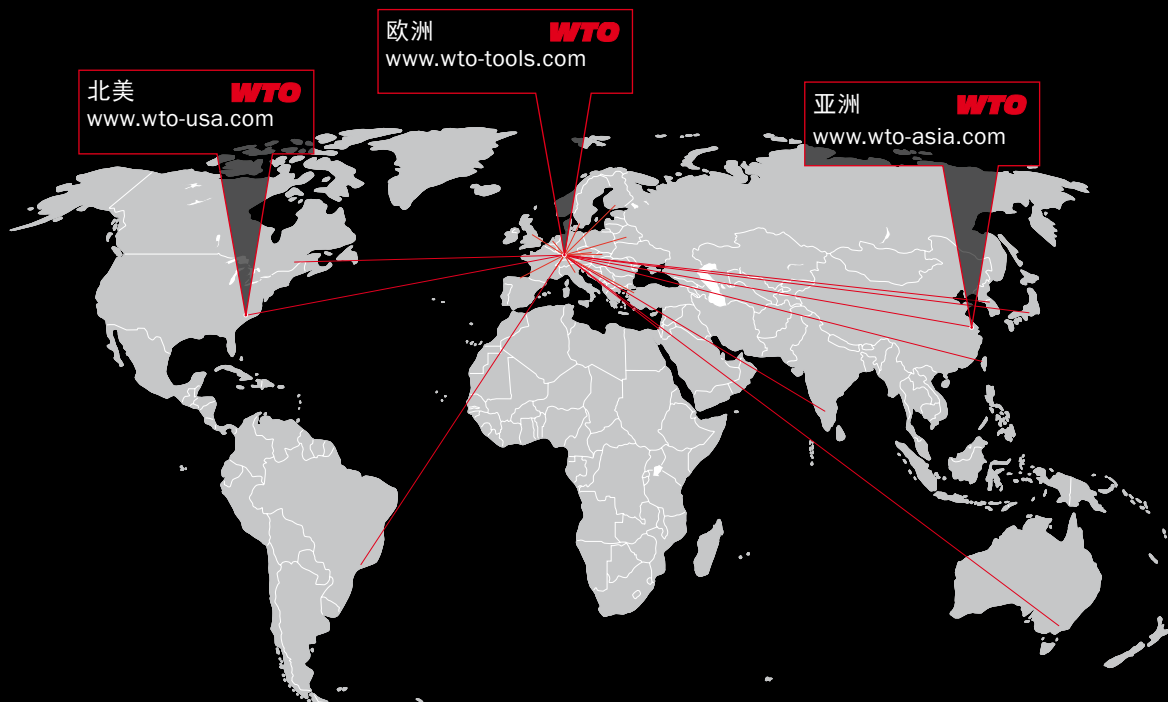

北美  
www.wto-usa.com

欧洲  
www.wto-tools.com

亚洲  
www.wto-asia.com

WTO Werkzeug-  
Einrichtungen GmbH  
有限公司  
Neuer Hohdammweg 1  
77797 Ohlsbach  
德国

WTO Inc. 美国分公司  
13900-F South Lakes Dr.  
Charlotte, NC 28273  
美国

WTO 亚洲  
上海市松江区九亭镇  
伴亭路228号2号楼  
109-110 室  
邮编: 201615 上海  
中国

在您所在地的WTO得力的销售伙伴为您提供产品咨询服务

澳大 亚  
Dimac Tooling Ltd.  
sales@dimac.com.au

英国  
Cutwel Ltd.  
sales@cutwel.net

韩国  
WTO Office Korea  
is.chon@wto-korea.com

瑞士  
Utilis AG  
info@utilis.com

巴西  
TF2  
tfdois@tfdois.com.br

匈牙利  
Prevotex Hungary Kft.  
info@prevotex.hu

墨西哥  
Workholding Engineering De México  
info@wem.com.mx

斯洛伐克  
ALBA precision s.r.o.  
albabprecision@albabprecision.sk

中国  
Shanghai Gangde  
wtocando@yahoo.com

印度  
Ulhas Patil  
u.patil@wto-asia.com

荷兰  
Toologic BeNeLux B.V.  
info@toologic-benelux.nl

西班牙  
ITALMATIC, S.A.  
italmatic@italmatic.es

丹麦  
AVN Teknik A/S  
cjo@avn.dk

以色列  
E.Y.A.R. Ltd.  
boris@eyar.co.il

挪威  
Helge Karlsen Verktøy og Maskin AS  
hkvm@hkvm.no

台湾  
Kaiko Co., Ltd.  
info@kaiko.com.tw

芬兰  
Suomen Terätuonti Oy  
myynti@stt.as

意大利  
Prymark srl  
commerciale@prymark.it

波兰  
ARCO Andrzej Rudenko  
info@arcotools.pl

土耳其  
MYK CNC MAKINA SAN. VE  
huseyin.tatlidil@mykcnc.com.tr

法国, 东部  
Christophe Archambault  
alm@wto.de

日本  
NK Works Co. Ltd.  
k\_samba@nk-works.co.jp

罗马尼亚  
SC Elif Trading SRL  
bulent.ozkan@eliftrading.com

捷克  
ALBA precision, spol. s.r.o.  
info@albabprecision.cz

法国, 西部  
Christophe Archambault  
car@wto.de

加拿大  
Mittmann Industrial Inc.  
info@mittmann.com

瑞典  
Bonhron & Ewing AB  
info@bonhron-ewing.se

乌克兰  
„LLC“ SPA Stankopromimport  
info@phoenix-ua.com